

High Efficient Surface Mount Rectifiers

FEATURES

- Glass passivated chip junction
- Ideal for automated placement
- Low forward voltage drop
- Ultrafast recovery time for high efficiency
- Built-in strain relief
- Moisture sensitivity level: level 1, per J-STD-020
- Compliant to RoHS Directive 2011/65/EU and in accordance to WEEE 2002/96/EC
- Halogen-free according to IEC 61249-2-21 definition

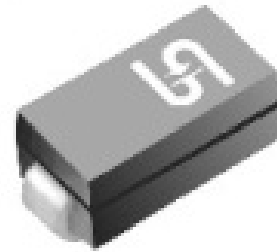

DO-214AC (SMA)

MECHANICAL DATA

Case: DO-214AC (SMA)

Molding compound, UL flammability classification rating 94V-0

Base P/N with suffix "G" on packing code - Green compound (halogen-free)

Base P/N with prefix "H" on packing code - AEC-Q101 qualified

Terminal: Matte tin plated leads, solderable per JESD22-B102

Meet JESD 201 class 1A whisker test

with prefix "H" on packing code meet JESD 201 class 2 whisker test

Polarity: Indicated by cathode band

Weight: 0.06 g (approximately)

MAXIMUM RATINGS AND ELECTRICAL CHARACTERISTICS (T _A =25°C unless otherwise noted)									
PARAMETER	SYMBOL	US 1A	US 1B	US 1D	US 1G	US 1J	US 1K	US 1M	UNIT
Maximum repetitive peak reverse voltage	V _{RRM}	50	100	200	400	600	800	1000	V
Maximum RMS voltage	V _{RMS}	35	70	140	280	420	560	700	V
Maximum DC blocking voltage	V _{DC}	50	100	200	400	600	800	1000	V
Maximum average forward rectified current	I _{F(AV)}	1							A
Peak forward surge current, 8.3 ms single half sine-wave superimposed on rated load	I _{FSM}	30							A
Maximum instantaneous forward voltage (Note 1) @ 1 A	V _F	1.0			1.7			V	
Maximum reverse current @ rated VR T _J =25 °C T _J =125 °C	I _R	5 150							μA
Maximum reverse recovery time (Note 2)	T _{rr}	50			75			ns	
Typical junction capacitance (Note 3)	C _j	15			10			pF	
Typical thermal resistance	R _{θjL} R _{θjA}	27 75							°C/W
Operating junction temperature range	T _J	- 55 to +150							°C
Storage temperature range	T _{STG}	- 55 to +150							°C

Note 1: Pulse test with PW=300μs, 1% duty cycle

Note 2: Reverse Recovery Test Conditions: I_F=0.5A, I_R=1.0A, I_{RR}=0.25A

Note 3: Measured at 1 MHz and Applied Reverse Voltage of 4.0V D.C.

ORDERING INFORMATION					
PART NO.	AEC-Q101 QUALIFIED	PACKING CODE	GREEN COMPOUND CODE	PACKAGE	PACKING
US1x (Note 1)	Prefix "H"	R3	Suffix "G"	SMA	1,800 / 7" Plastic reel
		R2		SMA	7,500 / 13" Paper reel
		M2		SMA	7,500 / 13" Plastic reel
		F3		Folded SMA	1,800 / 7" Plastic reel
		F2		Folded SMA	7,500 / 13" Paper reel
		F4		Folded SMA	7,500 / 13" Plastic reel
	N/A	E3		Clip SMA	1,800 / 7" Plastic reel
		E2		Clip SMA	7,500 / 13" Plastic reel

Note 1: "x" defines voltage from 50V (US1A) to 1000V (US1M)

EXAMPLE					
PREFERRED P/N	PART NO.	AEC-Q101 QUALIFIED	PACKING CODE	GREEN COMPOUND CODE	DESCRIPTION
US1M R3	US1M		R3		
US1M R3G	US1M		R3	G	Green compound
US1MHR3	US1M	H	R3		AEC-Q101 qualified

RATINGS AND CHARACTERISTICS CURVES

(TA=25°C unless otherwise noted)

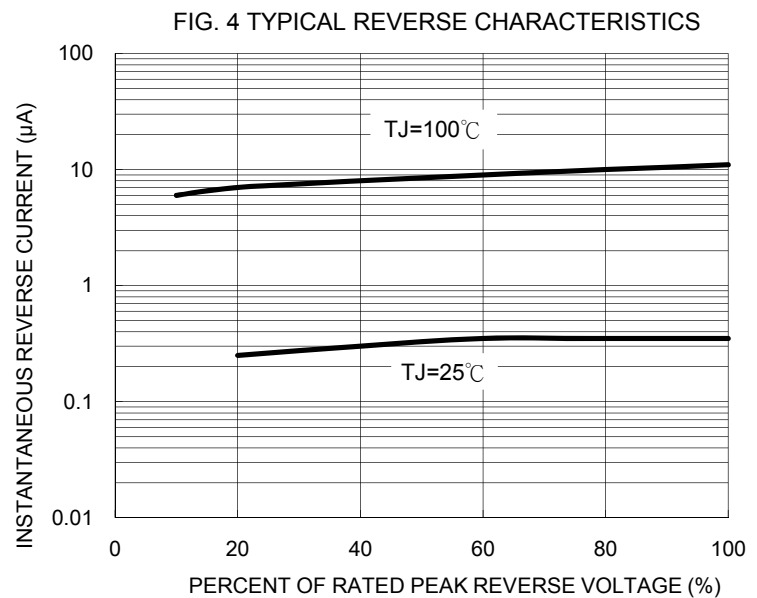
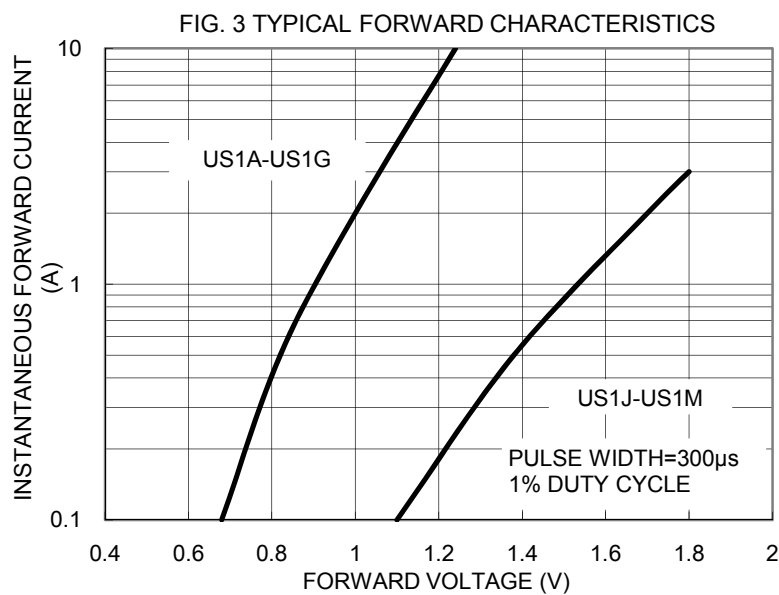
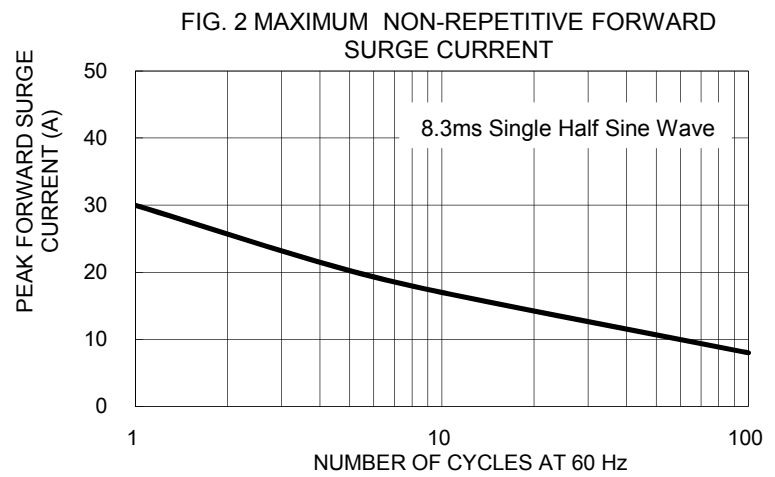
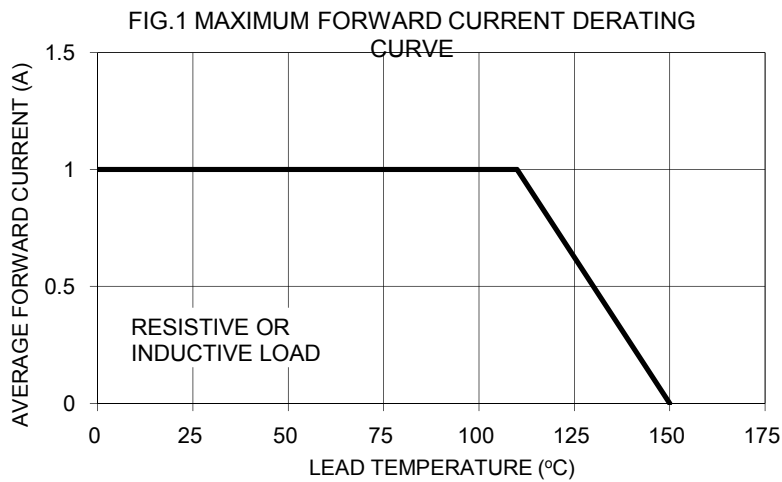

FIG. 5 TYPICAL JUNCTION CAPACITANCE

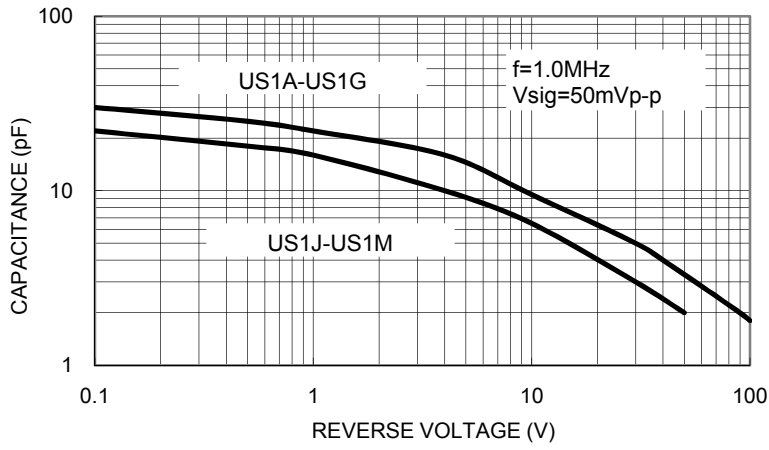

FIG. 6 TYPICAL TRANSIENT THERMAL IMPEDANCE

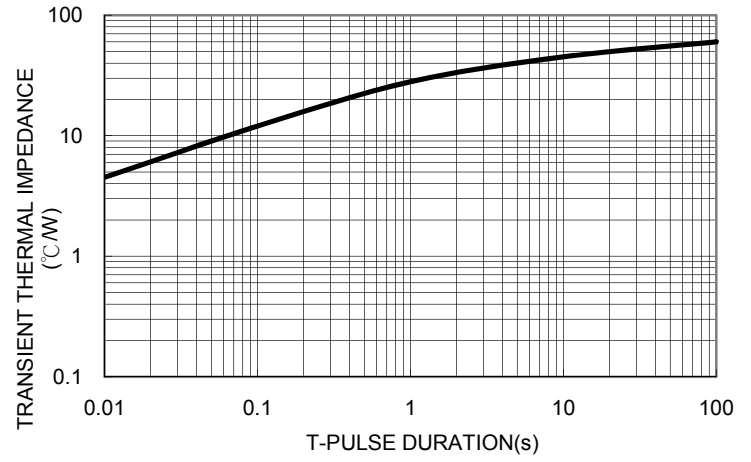
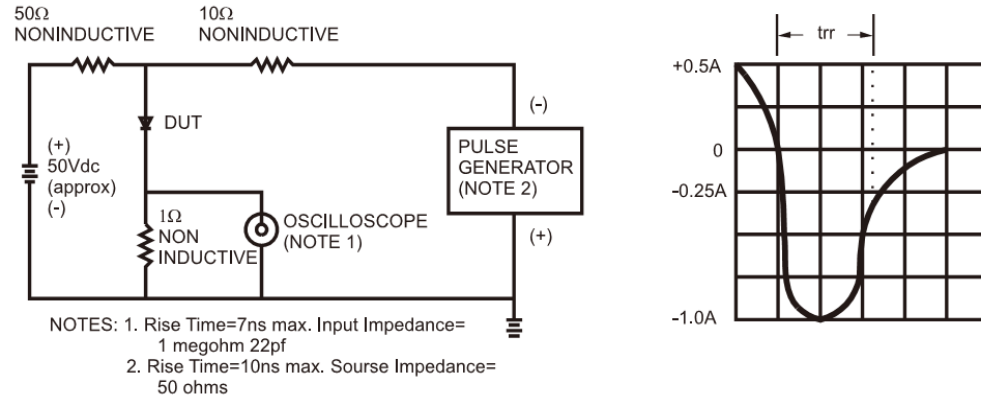
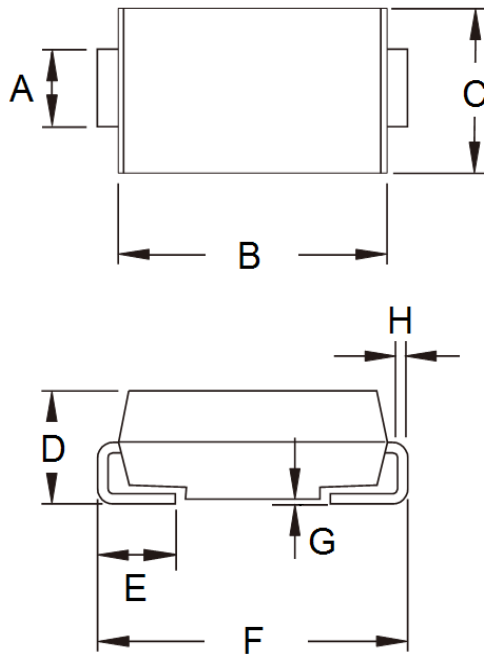

FIG.7- REVERSE RECOVERY TIME CHARACTERISTIC AND TEST CIRCUIT DIAGRAM



PACKAGE OUTLINE DIMENSIONS



DIM.	Unit (mm)		Unit (inch)	
	Min	Max	Min	Max
A	1.27	1.58	0.050	0.062
B	4.06	4.60	0.160	0.181
C	2.29	2.83	0.090	0.111
D	1.99	2.50	0.078	0.098
E	0.90	1.41	0.035	0.056
F	4.95	5.33	0.195	0.210
G	0.10	0.20	0.004	0.008
H	0.15	0.31	0.006	0.012

SUGGESTED PAD LAYOUT

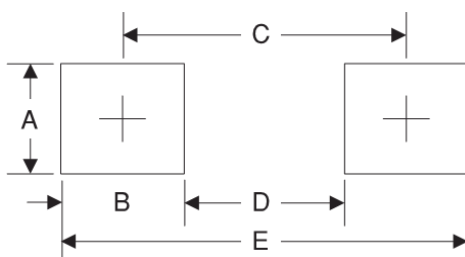

Symbol	Unit (mm)	Unit (inch)
A	1.68	0.066
B	1.52	0.060
C	3.93	0.155
D	2.41	0.095
E	5.45	0.215

MARKING DIAGRAM



- P/N = Specific Device Code
- G = Green Compound
- YW = Date Code
- F = Factory Code

Notice

Specifications of the products displayed herein are subject to change without notice. TSC or anyone on its behalf, assumes no responsibility or liability for any errors inaccuracies.

Information contained herein is intended to provide a product description only. No license, express or implied, to any intellectual property rights is granted by this document. Except as provided in TSC's terms and conditions of sale for such products, TSC assumes no liability whatsoever, and disclaims any express or implied warranty, relating to sale and/or use of TSC products including liability or warranties relating to fitness for a particular purpose, merchantability, or infringement of any patent, copyright, or other intellectual property right.

The products shown herein are not designed for use in medical, life-saving, or life-sustaining applications. Customers using or selling these products for use in such applications do so at their own risk and agree to fully indemnify TSC for any damages resulting from such improper use or sale.